

# Nylon Metric Cable Glands

## Range: Cable Glands/Grommets

Order Code: 150M16UMzXz

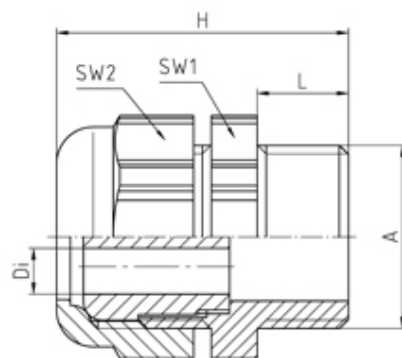

### DESCRIPTION

Uni-Dicht cable gland M16 with multiple hole sealing insert, see comments

*Subject to technical modification without notice.*

*Typographical and other errors do not justify claim for damages.*

## SPECIFICATION

<b>Product Type</b>	Standard
<b>Body Material</b>	Polyamide
<b>Min Temperature Rating °C</b>	-20
<b>Max Temperature Rating °C</b>	100
<b>IP Rating</b>	68
<b>Thread Size</b>	M16
<b>External Connecting Thread Type</b>	Metric
<b>Sealing Insert</b>	TPE
<b>Interior Diameter (mm)</b>	4x3
<b>Comments</b>	please indicate required sealing insert, e.g. 150M16UM2x4
<b>Connecting Thread Size</b>	M16x1.5
<b>Additional Material Detail</b>	Body - Polyamide PA6-3
<b>Standards</b>	EN50262

## INDUSTRY ACCREDITATIONS

**EN**