

Nylon Metric Cable Glands

Range: Cable Glands/Grommets

Order Code: GCG-PMG-M16-06GL (18M160465 T)

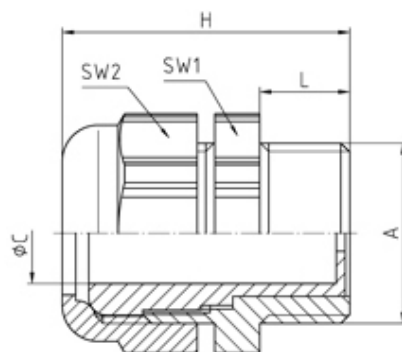

DESCRIPTION

Uni-Dicht cable gland M16X1.5 thread length 9 min/max cable dia 4-6.5

Subject to technical modification without notice.

Typographical and other errors do not justify claim for damages.

SPECIFICATION

Product Type	Standard
Body Material	Polyamide
Min Temperature Rating °C	-20
Max Temperature Rating °C	120
IP Rating	68
Colour	Pebble Grey - RAL 7032
Thread Size	M16
Clamping Range Min (mm)	4
Clamping Range Max (mm)	6.5
External Connecting Thread Type	Metric
Thread Length (mm)	9
Sealing Insert	TPE, colour coded
Width Across Flat 1 (mm)	19
Width Across Flat 2 (mm)	19
Height (mm)	31
Connecting Thread Size	M16x1.5
Additional Material Detail	Body - Polyamide PA6-3

INDUSTRY ACCREDITATIONS

EN