

Nylon Metric Cable Glands

Range: Cable Glands/Grommets

Order Code: GCG-NFC-M40-GL (50.640 PA7035FK1)

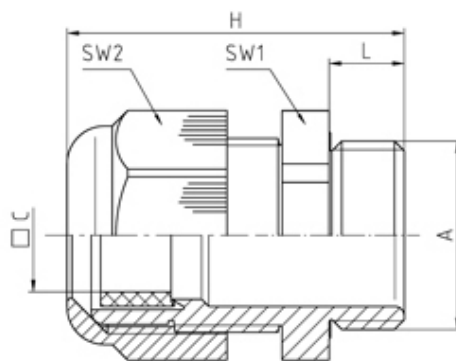

DESCRIPTION

Perfect cable gland with flat cable sealing insert PA7035 M40X1,5 thread length 10, min/max cable dia -3x19

CABLE GLANDS/GROMMETS FEATURES

- IP66
- Temp range -20°C to +100°C
- Quick and easy installation without special tools.
- Wall thickness 1-4mm

Subject to technical modification without notice.

Typographical and other errors do not justify claim for damages.

SPECIFICATION

Product Type	Standard
Body Material	Polyamide
Min Temperature Rating °C	-20
Max Temperature Rating °C	100
IP Rating	66
Colour	Light Grey - RAL 7035
Thread Size	M40
Clamping Range Max (mm)	3x19
External Connecting Thread Type	Metric
Thread Length (mm)	10
Sealing Insert	Evoprene TPE
Comments	sealing inserts - see WJ-DM xxFK1
Width Across Flat 1 (mm)	46
Width Across Flat 2 (mm)	46
Height (mm)	51
Connecting Thread Size	M40x1.5
Additional Material Detail	Body - Polyamide PA6 V-2