

Nylon Metric Cable Glands

Range: Cable Glands/Grommets

Order Code: GCG-NMF-M25-BK (50.625 PA/FLSW)

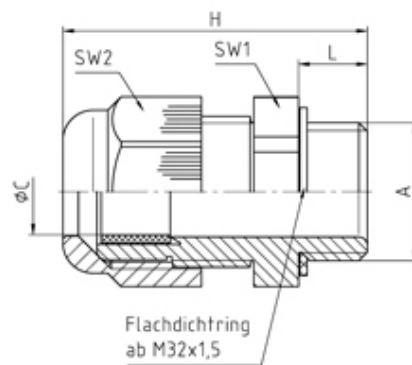

DESCRIPTION

Perfect cable gland PA/SW M25X1,5 thread length 8, min/max cable dia 11-17 Body - Polyamide PA6 V-0

*Subject to technical modification without notice.
Typographical and other errors do not justify claim for damages.*

SPECIFICATION

Product Type	Standard
Sealing Ring Material	Polychloroprene-Nitrile rubber CR/NBR
Body Material	Polyamide
Min Temperature Rating °C	-20
Max Temperature Rating °C	100
IP Rating	68
Colour	Black - RAL 9005
Thread Size	M25
Clamping Range Min (mm)	11
Clamping Range Max (mm)	17
External Connecting Thread Type	Metric
Thread Length (mm)	8
Comments	details about tests - see annex
Width Across Flat 1 (mm)	29
Width Across Flat 2 (mm)	29
Height (mm)	43
Connecting Thread Size	M25x1.5
Additional Material Detail	Body - Polyamide PA6 V-0
Standards	UL514B

INDUSTRY ACCREDITATIONS

