

Nylon Metric Cable Glands

Range: Cable Glands/Grommets

Order Code: GCG-NCR-M32-BK (50029M32PASWR)

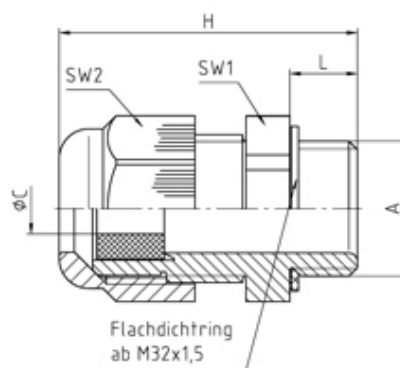

DESCRIPTION

Perfect cable gland PA/SW reducer M32 thread length 15, min/max cable dia 12-20 Body - Polyamide PA6 V-2

Subject to technical modification without notice.

Typographical and other errors do not justify claim for damages.

SPECIFICATION

Product Type	Standard
Sealing Ring Material	Polychloroprene-Nitrile rubber CR/NBR
Body Material	Polyamide
Min Temperature Rating °C	-20
Max Temperature Rating °C	100
IP Rating	68
Colour	Black - RAL 9005
Thread Size	M32
Clamping Range Min (mm)	12
Clamping Range Max (mm)	20
External Connecting Thread Type	Metric
Thread Length (mm)	15
Comments	details about tests - see annex
Width Across Flat 1 (mm)	42
Width Across Flat 2 (mm)	42
Height (mm)	57
Connecting Thread Size	M32x1.5
Additional Material Detail	Body - Polyamide PA6 V-2
Standards	EN50262/UL514B

INDUSTRY ACCREDITATIONS

