

Nylon Metric Cable Glands

Range: Cable Glands/Grommets

Order Code: GCG-NCR-M63-GL (50048M63PAR7035)

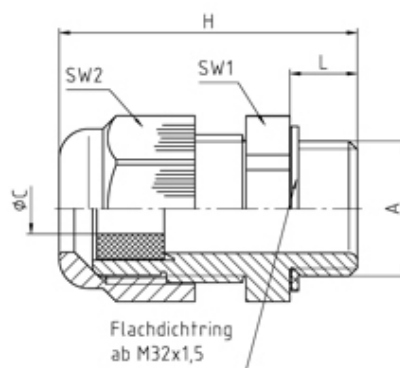

DESCRIPTION

Perfect cable gland PA7035 reducer M63 thread length 18, min/max cable dia 29-35 Body - Polyamide PA6 V-2

Subject to technical modification without notice.

Typographical and other errors do not justify claim for damages.

SPECIFICATION

Product Type	Standard
Sealing Ring Material	Polychloroprene-Nitrile rubber CR/NBR
Body Material	Polyamide
Min Temperature Rating °C	-20
Max Temperature Rating °C	100
IP Rating	68
Colour	Light Grey - RAL 7035
Thread Size	M63
Clamping Range Min (mm)	29
Clamping Range Max (mm)	35
External Connecting Thread Type	Metric
Thread Length (mm)	18
Comments	details about tests - see annex
Width Across Flat 1 (mm)	65
Width Across Flat 2 (mm)	65
Height (mm)	73
Connecting Thread Size	M63x1.5
Additional Material Detail	Body - Polyamide PA6 V-2
Standards	EN50262/UL514B

INDUSTRY ACCREDITATIONS

