

Nylon Metric Cable Glands

Range: Cable Glands/Grommets

Order Code: GCG-NCR-M25-GL (50021M25PAR7035)

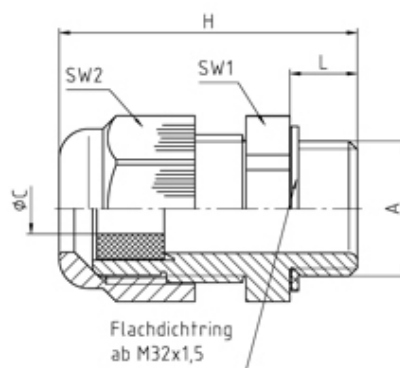

DESCRIPTION

Perfect cable gland PA7035 reducer M25 thread length 15, min/max cable dia 9-16 Body - Polyamide PA6 V-2

Subject to technical modification without notice.

Typographical and other errors do not justify claim for damages.

SPECIFICATION

Product Type	Standard
Sealing Ring Material	Polychloroprene-Nitrile rubber CR/NBR
Body Material	Polyamide
Min Temperature Rating °C	-20
Max Temperature Rating °C	100
IP Rating	68
Colour	Light Grey - RAL 7035
Thread Size	M25
Clamping Range Min (mm)	9
Clamping Range Max (mm)	16
External Connecting Thread Type	Metric
Thread Length (mm)	15
Comments	details about tests - see annex
Width Across Flat 1 (mm)	33
Width Across Flat 2 (mm)	33
Height (mm)	52
Connecting Thread Size	M25x1.5
Additional Material Detail	Body - Polyamide PA6 V-2
Standards	EN50262/UL514B

INDUSTRY ACCREDITATIONS

