

## 50013M20PAR

Perfect cable gland PA7001 reducer M20/PG13 thread length 11, min/max cable dia 5-9 Body - Polyamide PA6 V-2

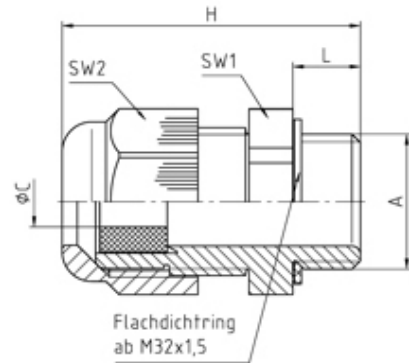

### SPECIFICATION

Product Type	Standard
Sealing Ring Material	Polychloroprene-Nitrile rubber CR/NBR
Body Material	Polyamide
Min Temperature Rating °C	-20
Max Temperature Rating °C	100
IP Rating	68
Colour	Dark Grey - RAL 7001
Thread Size	M20
Clamping Range Min (mm)	5
Clamping Range Max (mm)	9
External Connecting Thread Type	Metric
Thread Length (mm)	11
Comments	details about tests - see annex
Width Across Flat 1 (mm)	24
Width Across Flat 2 (mm)	24
Height (mm)	41.5
Connecting Thread Size	M20x1.5
Additional Material Detail	Body - Polyamide PA6 V-2
Standards	EN50262/UL514B