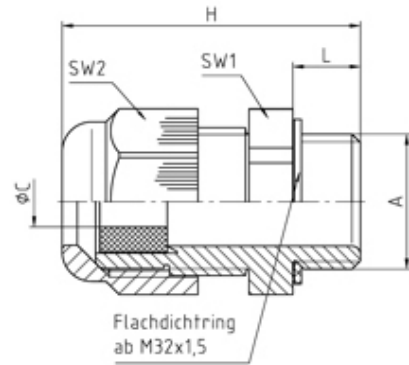

**50011M16PAR**

Perfect cable gland PA7001 reducer M16/PG11 thread length 15, min/max cable dia 3-7 Body - Polyamide PA6 V-2

**SPECIFICATION**

<b>Product Type</b>	Standard
<b>Sealing Ring Material</b>	Polychloroprene-Nitrile rubber CR/NBR
<b>Body Material</b>	Polyamide
<b>Min Temperature °C</b>	-20
<b>Max Temperature °C</b>	100
<b>IP Rating</b>	68
<b>Colour</b>	Dark Grey - RAL 7001
<b>Thread Size</b>	M16
<b>Clamping Range Min (mm)</b>	3
<b>Clamping Range Max (mm)</b>	7
<b>External Connecting Thread Type</b>	Metric
<b>Thread Length (mm)</b>	15
<b>Comments</b>	details about tests - see annex
<b>Width Across Flat 1 (mm)</b>	22
<b>Width Across Flat 2 (mm)</b>	22
<b>Height (mm)</b>	44
<b>Connecting Thread Size</b>	M16x1.5
<b>Additional Material Detail</b>	Body - Polyamide PA6 V-2
<b>Standards</b>	EN50262/UL514B