

50.625 PA/R

Perfect cable gland PA7001 reducer M25X1,5 thread length 8, min/max cable dia 8-17 Body - Polyamide PA6 V-2

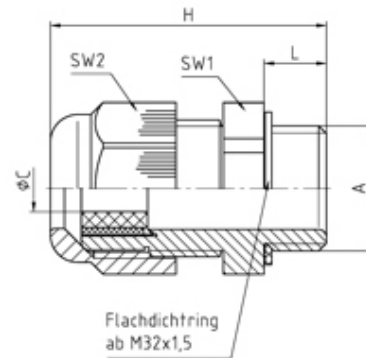

SPECIFICATION

Product Type	Standard
Body Material	Polyamide
Min Temperature °C	-20
Max Temperature °C	100
IP Rating	68
Colour	Dark Grey - RAL 7001
Thread Size	M25
Clamping Range Min (mm)	8
Clamping Range Max (mm)	17
External Connecting Thread Type	Metric
Thread Length (mm)	8
Sealing Ring/Inner Part	Evoprene TPE
Comments	details about tests - see annex
Width Across Flat 1 (mm)	29
Width Across Flat 2 (mm)	29
Height (mm)	43
Connecting Thread Size	M25x1.5
Sealing Ring/Outer Part	Polychloroprene-Nitrile rubber CR/NBR
Additional Material Detail	Body - Polyamide PA6 V-2
Standards	EN50262/UL514B

DISTRIBUTORS

