

TeeTube

Range: Weatherproof/Waterproof Connectors

Order Code: THP.391.C4A



Product Image
Not Available

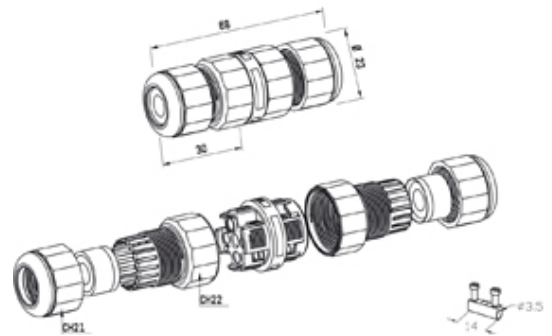

DESCRIPTION

TeeTube Mini Panel-mount Mini 4 Pole Screw - piercing 7mm to 12mm, 1.5mm max conductor size IP68 17.5A 450V 2 cable entries

WEATHERPROOF/WATERPROOF CONNECTORS FEATURES

- Tough, robust construction with large cable range acceptance
- Straight through, T splitter and Y splitter versions available
- Dual terminal versions available for easy fitting and looping of conductors (2+2 and 3+3 poles)
- Temperature rating of -40°C to +125°C

Features may vary by product throughout the range.

Subject to technical modification without notice.

Typographical and other errors do not justify claim for damages.

SPECIFICATION

Cable Entries	2
Max Current (A)	17.5
Max Voltage (V)	450
Number of Poles	4
Min Conductor Size (Sq mm)	0.5
Max Conductor Size (Sq mm)	1.5
Minimum Cable Diameter (mm)	7
Maximum Cable Diameter (mm)	12
IP Rating	68
Min Temperature Rating °C	-40
Max Temperature Rating °C	125
Temperature "T" Rating	T125
Body Material	PA66 / PBT / TPE
Fixing System	Cable
Terminal Type	Screw - piercing

INDUSTRY ACCREDITATIONS

