

50036M40PA

Perfect cable gland PA7001 long connecting thread M40/PG36 thread length 18, min/max cable dia 22-32 Body - Polyamide PA6 V-2

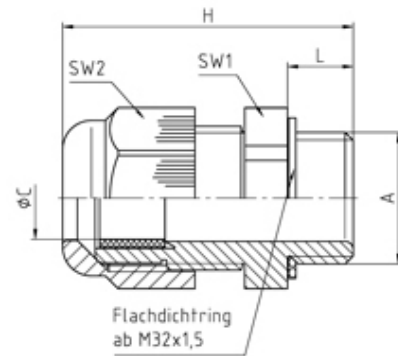

SPECIFICATION

Product Type	Standard
Sealing Ring Material	Polychloroprene-Nitrile rubber CR/NBR
Body Material	Polyamide
Min Temperature °C	-20
Max Temperature °C	100
IP Rating	68
Colour	Dark Grey - RAL 7001
Thread Size	M40
Clamping Range Min (mm)	22
Clamping Range Max (mm)	32
External Connecting Thread Type	Metric
Thread Length (mm)	18
Comments	details about tests - see annex
Width Across Flat 1 (mm)	53
Width Across Flat 2 (mm)	53
Height (mm)	69
Connecting Thread Size	M40x1.5
Additional Material Detail	Body - Polyamide PA6 V-2
Standards	EN50262/UL514B