

50013M20PA

Perfect cable gland PA7001 long connecting thread M20/PG13 thread length 11, min/max cable dia 6-12 Body - Polyamide PA6 V-2

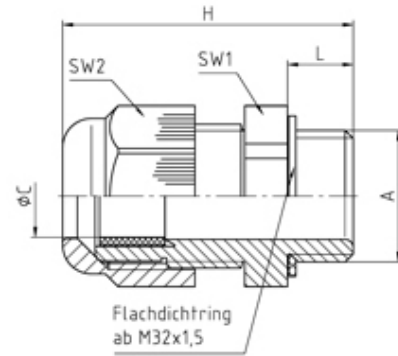

SPECIFICATION

Product Type	Standard
Sealing Ring Material	Polychloroprene-Nitrile rubber CR/NBR
Body Material	Polyamide
Min Temperature °C	-20
Max Temperature °C	100
IP Rating	68
Colour	Dark Grey - RAL 7001
Thread Size	M20
Clamping Range Min (mm)	6
Clamping Range Max (mm)	12
External Connecting Thread Type	Metric
Thread Length (mm)	11
Comments	details about tests - see annex
Width Across Flat 1 (mm)	24
Width Across Flat 2 (mm)	24
Height (mm)	41.5
Connecting Thread Size	M20x1.5
Additional Material Detail	Body - Polyamide PA6 V-2
Standards	EN50262/UL514B