

THB.399.D3A

TeeTube 3 Pole Screw - end barrier contact 8mm to 17mm , 4 mm max conductor size IP68 32A 250V 3 cable entries

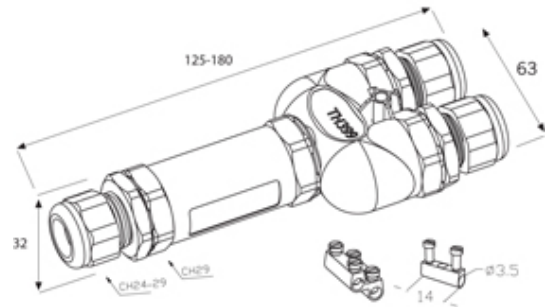

Product Image
Not Available



SPECIFICATION

Cable Entries	3
Number of Poles	3
Terminal Type	Screw - end barrier contact
Body Material	PA66 / TPE
IP Rating	68
Max Conductor Size (Sq mm)	4
Max Current (A)	32
Max Voltage (V)	250
Minimum Temp Rating °C	-40
Maximum Temp Rating °C	125
Minimum Cable Diameter (mm)	7
Maximum Cable Diameter (mm)	17
Fixing System	Cable
Temperature "T" Rating	T85