

50.663 PA7035

Perfect cable gland PA7035 M63X1,5 thread length 12, min/max cable dia 32-45 Body - Polyamide PA6 V-2

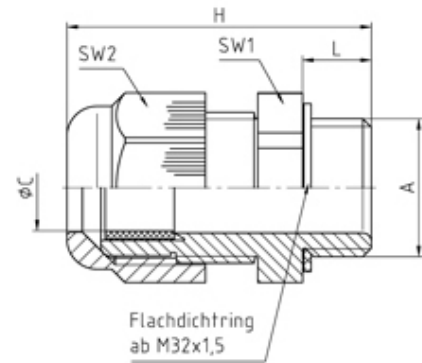

SPECIFICATION

Product Type	Standard
Sealing Ring Material	Polychloroprene-Nitrile rubber CR/NBR
Body Material	Polyamide
Min Temperature °C	-20
Max Temperature °C	100
IP Rating	68
Colour	Light Grey - RAL 7035
Thread Size	M63
Clamping Range Min (mm)	32
Clamping Range Max (mm)	45
External Connecting Thread Type	Metric
Thread Length (mm)	12
Comments	details about tests - see annex
Width Across Flat 1 (mm)	68
Width Across Flat 2 (mm)	68
Height (mm)	65.5
Connecting Thread Size	M63x1.5
Additional Material Detail	Body - Polyamide PA6 V-2
Standards	EN50262/UL514B