

## 50.612 PA7001

Perfect cable gland PA7001 M12X1,5 thread length 8, min/max cable dia 3-6 Body - Polyamide PA6 V-2

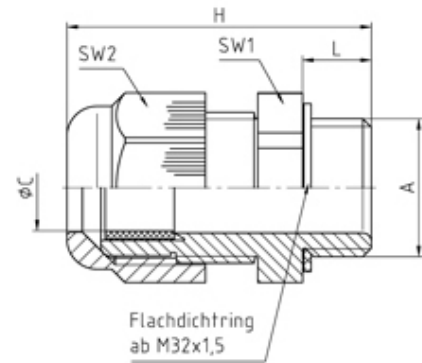

### SPECIFICATION

Product Type	Standard
Sealing Ring Material	Polychloroprene-Nitrile rubber CR/NBR
Body Material	Polyamide
Min Temperature °C	-20
Max Temperature °C	100
IP Rating	68
Colour	Dark Grey - RAL 7001
Thread Size	M40
Clamping Range Min (mm)	3
Clamping Range Max (mm)	6
External Connecting Thread Type	Metric
Thread Length (mm)	8
Comments	details about tests - see annex
Width Across Flat 1 (mm)	15
Width Across Flat 2 (mm)	15
Height (mm)	31
Connecting Thread Size	M12x1.5
Additional Material Detail	Body - Polyamide PA6 V-2
Standards	EN50262/UL514B