

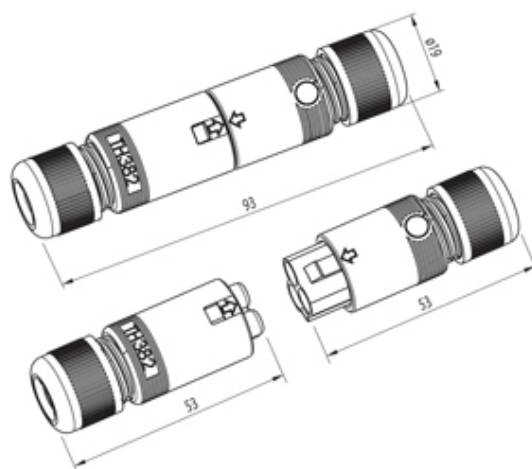

TeePlug & Sockets

Range: Weatherproof/Waterproof Connectors

Order Code: THB.382.B2A.AG



DESCRIPTION

TeePlug Powersocket 2 pole Screw silver plated terminal 7mm to 9.5mm cable diameter, 4 mm max conductor size IP40 17A 400V 1 cable entry

WEATHERPROOF/WATERPROOF CONNECTORS FEATURES

- Up to IP68 versions available
- Various configurations available
- Components are keyway coded to ensure correct assembly
- All products are quick and simple to install
- Bulkhead/chassis mount options available (depending on product type)
- Temperature range of -20°C to +125°C

Features may vary by product throughout the range.

Subject to technical modification without notice.

Typographical and other errors do not justify claim for damages.

SPECIFICATION

Type	Socket
Cable Entries	1
Max Current (A)	17
Max Voltage (V)	400
Number of Poles	2
Max Conductor Size (Sq mm)	4
Minimum Cable Diameter (mm)	7
Maximum Cable Diameter (mm)	9.5
IP Rating	40
Min Temperature Rating °C	-40
Max Temperature Rating °C	125
Temperature "T" Rating	T85
Body Material	PA66
Fixing System	Cable
Terminal Type	Screw silver plated

INDUSTRY ACCREDITATIONS

