

TeeBox

Range: Weatherproof/Waterproof Connectors

Order Code: THB.110.C3A

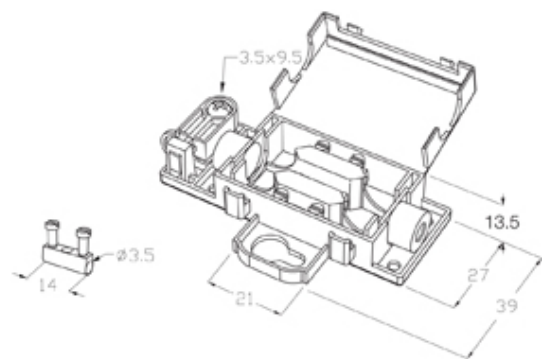

DESCRIPTION

TeeBox 2.5mm conductor max IP44 rated Snap in fixing 2 cable entries, 3 poles with double cable clamp

WEATHERPROOF/WATERPROOF CONNECTORS FEATURES

- Comprehensive range of connection options
- Protection rating up to IP68 depending on product
- Unique 3 pole T connector TH029 available for use in TH209 & TH211 range, no cable forming required
- TH211 available as full KIT version complete with TH029 fitted
- Power distribution products available in 3 port (TH630) and 4 port (TH62) versions
- Temperature range of -20°C to +125°C

Features may vary by product throughout the range.

Subject to technical modification without notice.

Typographical and other errors do not justify claim for damages.

SPECIFICATION

Cable Entries	2
Max Current (A)	24
Max Voltage (V)	450
Number of Poles	3
Max Conductor Size (Sq mm)	2.5
Maximum Cable Diameter (mm)	9
IP Rating	44
Min Temperature Rating °C	-40
Max Temperature Rating °C	125
Temperature "T" Rating	T85
Body Material	PA66
Fixing System	Snap in
Terminal Type	Standard

INDUSTRY ACCREDITATIONS

