

18M503640

Uni-Dicht cable gland M50X1,5 thread length 10 min/max cable dia 36-40

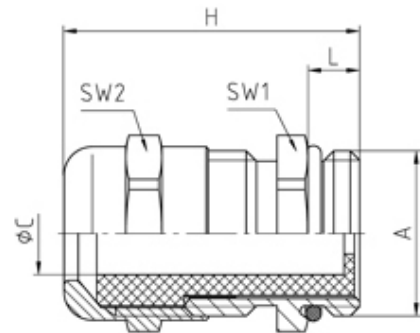

EN

SPECIFICATION

Product Type	Standard
Body Material	Nickel Plated Brass
Min Temperature °C	-20
Max Temperature °C	135
IP Rating	68
Thread Size	M50
Clamping Range Min (mm)	36
Clamping Range Max (mm)	40
External Connecting Thread Type	Metric
Thread Length (mm)	10
Sealing Insert	TPE, colour coded
Width Across Flat 1 (mm)	57
Width Across Flat 2 (mm)	57
Height (mm)	38
Connecting Thread Size	M50x1.5
Additional Material Detail	Body - Brass CuZn39Pb3 nickel plated, O-Ring - Nitrile rubber
Standards	EN50262