

18M402428

Uni-Dicht cable gland M40X1,5 thread length 8 min/max cable dia 24-28

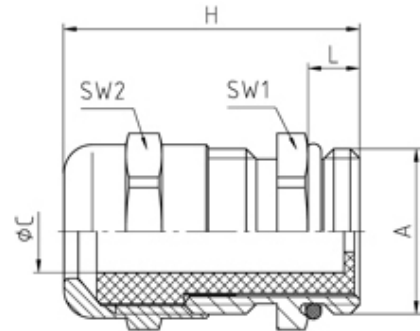

EN

SPECIFICATION

Product Type	Standard
Body Material	Nickel Plated Brass
Min Temperature °C	-20
Max Temperature °C	135
IP Rating	68
Thread Size	M40
Clamping Range Min (mm)	24
Clamping Range Max (mm)	28
External Connecting Thread Type	Metric
Thread Length (mm)	8
Sealing Insert	TPE, colour coded
Width Across Flat 1 (mm)	43
Width Across Flat 2 (mm)	40
Height (mm)	33
Connecting Thread Size	M40x1.5
Additional Material Detail	Body - Brass CuZn39Pb3 nickel plated, O-Ring - Nitrile rubber
Standards	EN50262