

50.612M/EMV/L

Perfect cable gland EMV M12X1,5 thread length 10, min/max cable dia 3-6

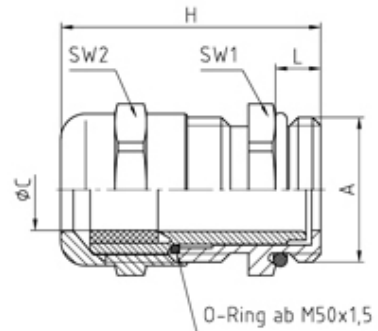

SPECIFICATION

Product Type	EMV/EMC
Sealing Ring Material	Polychloroprene-Nitrile rubber CR/NBR
Body Material	Nickel Plated Brass
Min Temperature °C	-20
Max Temperature °C	100
IP Rating	68
Thread Size	M12
Clamping Range Min (mm)	3
Clamping Range Max (mm)	6
Lamellar Insert Material	Polyamide PA6 V-2
External Connecting Thread Type	Metric
Thread Length (mm)	10
Comments	details about tests - see annex
Width Across Flat 1 (mm)	14
Width Across Flat 2 (mm)	14
Height (mm)	30
Connecting Thread Size	M12x1.5
Additional Material Detail	Body - Brass CuZn39Pb3 nickel plated, O-Ring - Nitrile rubber
Standards	EN50262/UL514B