

## 50.612 M/STO

Perfect cable gland with blanking sealing insert M12X1,5 thread length 5

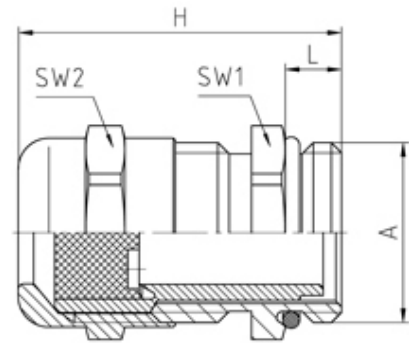

### SPECIFICATION

<b>Product Type</b>	Standard
<b>Body Material</b>	Nickel Plated Brass
<b>Min Temperature °C</b>	-20
<b>Max Temperature °C</b>	100
<b>IP Rating</b>	65
<b>Thread Size</b>	M12
<b>Lamellar Insert Material</b>	Polyamide PA6 V-2
<b>External Connecting Thread Type</b>	Metric
<b>Thread Length (mm)</b>	5
<b>Sealing Insert</b>	Evoprene TPE
<b>Comments</b>	sealing inserts - see WJ-DM xx STO
<b>Width Across Flat 1 (mm)</b>	14
<b>Width Across Flat 2 (mm)</b>	14
<b>Height (mm)</b>	25
<b>Connecting Thread Size</b>	M12x1.5
<b>Additional Material Detail</b>	Body - Brass CuZn39Pb3 nickel plated, O-Ring - Nitrile rubber