

50.620 M/ASI/2

Perfect cable gland with AS-I sealing insert M20X1,5 thread length 6, min/max cable dia -2 x AS-i Bus cable

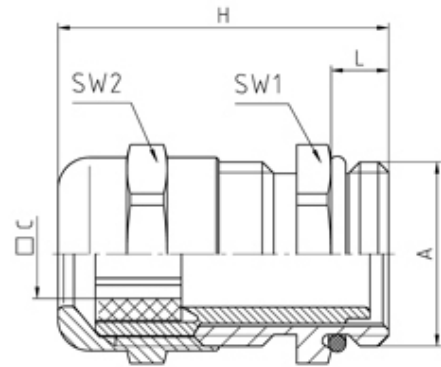

SPECIFICATION

Product Type	Standard
Body Material	Nickel Plated Brass
Min Temperature °C	-20
Max Temperature °C	100
IP Rating	65
Thread Size	M20
Clamping Range Max (mm)	1 x AS-i Bus-Leitung
Lamellar Insert Material	Polyamide PA6 V-2
External Connecting Thread Type	Metric
Thread Length (mm)	6
Sealing Insert	Evoprene TPE
Comments	sealing inserts - see WJ-DM xx/ASI/z
Width Across Flat 1 (mm)	22
Width Across Flat 2 (mm)	22
Height (mm)	33.5
Connecting Thread Size	M20x1.5
Additional Material Detail	Body - Brass CuZn39Pb3 nickel plated, O-Ring - Nitrile rubber