

## 50.616 PABLEXSI

Perfect cable gland EX M16X1,5 thread length 8, min/max cable dia 5.5-10, Sealing Ring material Silicone VMQ Gland Colour-Body Black RAL 9005 - Head Blue RAL 5015

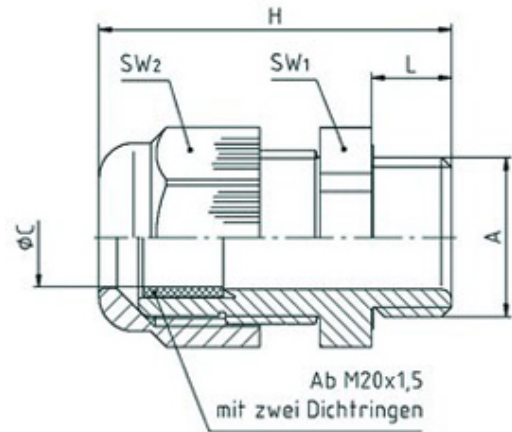

### SPECIFICATION

<b>Product Type</b>	EX
<b>Body Material</b>	Polyamide
<b>Min Temperature °C</b>	-20
<b>Max Temperature °C</b>	70
<b>IP Rating</b>	66
<b>Colour</b>	Body Black RAL 9005 - Head Blue RAL 5015
<b>Thread Size</b>	M16
<b>Clamping Range Min (mm)</b>	5.5
<b>Clamping Range Max (mm)</b>	10
<b>External Connecting Thread Type</b>	Metric
<b>Thread Length (mm)</b>	8
<b>Sealing Ring/Inner Part</b>	Evoprene TPE (from M20x1,5)
<b>Comments</b>	PTB 99 ATEX 3101 X (M12 und M16)2G, 2D and 3G/1, 2, 21, 22 Equipment Group IIEx e, increased safety EN 60079-0 / EN 60079-7
<b>Width Across Flat 1 (mm)</b>	20
<b>Width Across Flat 2 (mm)</b>	20
<b>Height (mm)</b>	35.5
<b>Connecting Thread Size</b>	M16x1.5
<b>Sealing Ring/Outer Part</b>	Silicone VMQ
<b>Additional Material Detail</b>	Body - Polyamide PA6, Dust cap - Polyethylene PE-LD
<b>Category/Zone</b>	2G, 2D and 3G/1, 2, 21, 22
<b>Equipment Group</b>	Equipment Group II
<b>Standards</b>	EN60079-1/EN60079-7/EN61241-0/EN61241-1
<b>Type of Protection</b>	Ex e, increased safety