

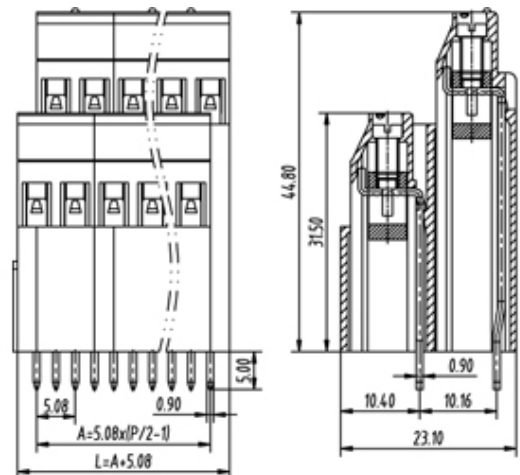

Rising Clamp - Double Decker PCB

Range: PCB Terminal Blocks, Connectors and Fuse Holders

Part Number: TL324VH2-38PKS



DESCRIPTION

38 Pole Screw Rising Clamp Vertical 5.08mm pitch 25A 300V

Subject to technical modification without notice.

Typographical and other errors do not justify claim for damages.

SPECIFICATION

Type	Screw
Connection Method	Rising Clamp
Mounting Type	Vertical
Orientation	Vertical
Join	Interlocking
Pitch (mm)	5.08
Number of Poles	38
Max Current (A)	25
Max Voltage (V)	300
Height (mm)	44.8
Standard Colour	Black
Width (mm)	23.1
Length (mm)	96.52
Solder Pin Length (mm)	5
PCB Hole Diameter (mm)	1.4-1.5
Body Material	PA66 V0