

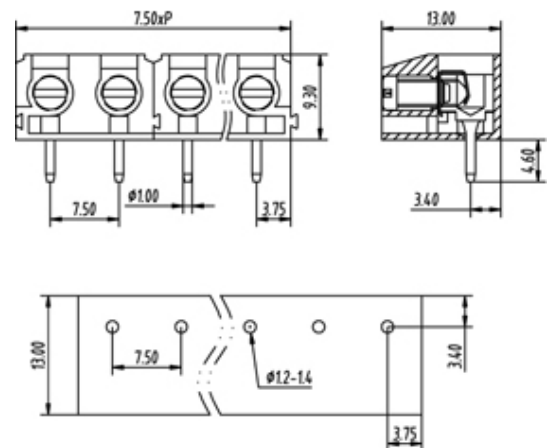

Through Hole Mount/Wire Protected

Range: PCB Terminal Blocks, Connectors and Fuse Holders

Part Number: TL400R-07PGS

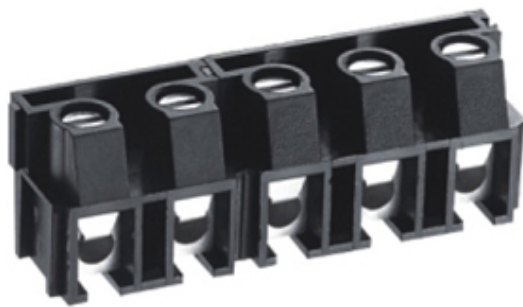

DESCRIPTION

7 Pole Screw Wire Protector Wave - through hole Horizontal 7.5mm pitch 24A 450V

Subject to technical modification without notice.

Typographical and other errors do not justify claim for damages.

SPECIFICATION

Type	Screw
Connection Method	Wire Protector
Mounting Type	Wave - through hole
Orientation	Horizontal
Join	Interlocking
Pitch (mm)	7.5
Number of Poles	7
Min Wire Size (Sq mm)	0.33
Max Wire Size (Sq mm)	2.5
Max Current (A)	24
Max Voltage (V)	450
Height (mm)	9.3
Standard Colour	Green
Width (mm)	13
Length (mm)	52.5
Solder Pin Length (mm)	4.2
PCB Hole Diameter (mm)	1.2-1.4
Approvals Pending	UL Pending
Body Material	PA66 V0
Comments	Pole sizes / no of ways not shown, please contact us for availability
Min Temperature Rating °C	-40
Max Temperature Rating °C	105
Min Wire Size AWG	22
Max Wire Size AWG	14
Terminal Type	Wire protected

INDUSTRY ACCREDITATIONS

