

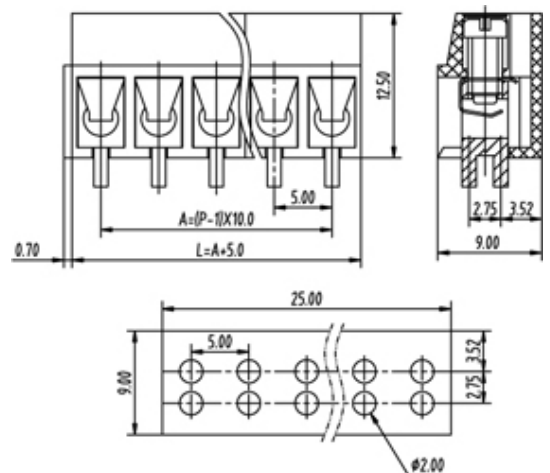

Through Hole Mount/Wire Protected

Range: PCB Terminal Blocks, Connectors and Fuse Holders

Part Number: TL213-19P



DESCRIPTION

19 Pole Screw Wire Protector Wave - through hole Vertical 5mm pitch 12A 300V

Subject to technical modification without notice.

Typographical and other errors do not justify claim for damages.

SPECIFICATION

Type	Screw
Connection Method	Wire Protector
Mounting Type	Wave - through hole
Orientation	Vertical
Join	Interlocking
Pitch (mm)	5
Number of Poles	19
Min Wire Size (Sq mm)	0.75
Max Wire Size (Sq mm)	2.5
Max Current (A)	12
Max Voltage (V)	300
Height (mm)	12.8
Standard Colour	Black
Width (mm)	8.6
Length (mm)	95
PCB Hole Diameter (mm)	1.4-1.6
Approvals Pending	UL Pending
Comments	Pole sizes / no of ways not shown, please contact us for availability
Min Temperature Rating °C	-40
Max Temperature Rating °C	105
Min Wire Size AWG	18
Max Wire Size AWG	12
Terminal Type	Wire protected