

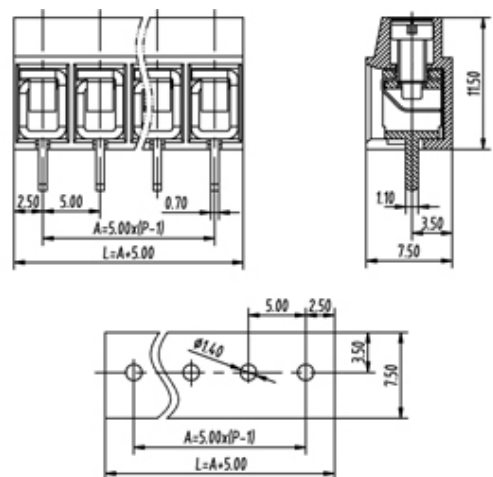

Through Hole Mount/Wire Protected

Range: PCB Terminal Blocks, Connectors and Fuse Holders

Part Number: TL226V-07PGS

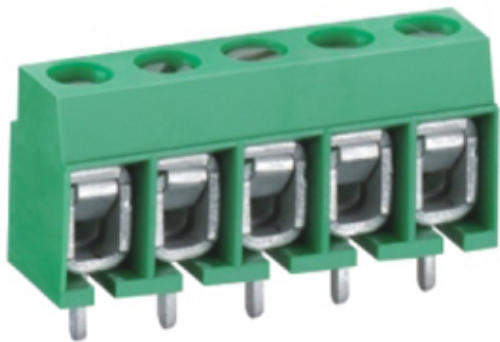

DESCRIPTION

7 Pole Screw Wire Protector Vertical 5mm pitch 16A(UL) 24A(VDE) 300V(UL) 250V(VDE)

Subject to technical modification without notice.

Typographical and other errors do not justify claim for damages.

SPECIFICATION

| | |
|-------------------------------|--------------------------|
| Type | Screw |
| Connection Method | Wire Protector |
| Mounting Type | Vertical |
| Orientation | Vertical |
| Join | Solid body non stackable |
| Pitch (mm) | 5 |
| Number of Poles | 7 |
| Max Current (A) | 16A(UL) 24A(VDE) |
| Max Voltage (V) | 300V(UL) 250V(VDE) |
| Height (mm) | 11.5 |
| Standard Colour | Green |
| Width (mm) | 7.5 |
| Length (mm) | 35 |
| PCB Hole Diameter (mm) | 1.4 |
| Body Material | PA66 V0 |