

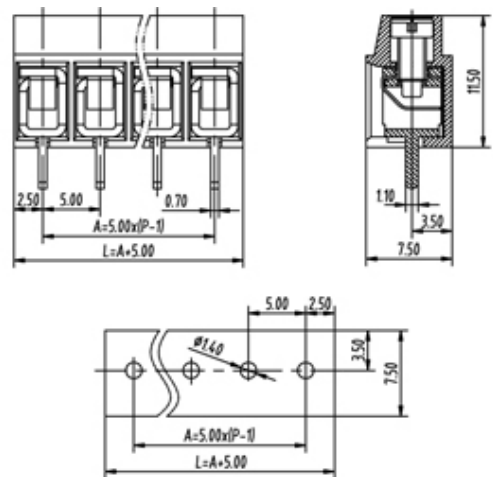

Through Hole Mount/Wire Protected

Range: PCB Terminal Blocks, Connectors and Fuse Holders

Part Number: TL226V-04PGS

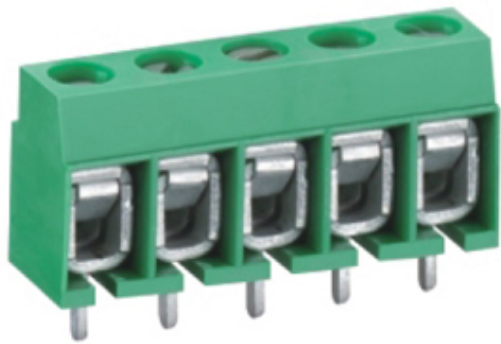

DESCRIPTION

4 Pole Screw Wire Protector Vertical 5mm pitch 16A(UL) 24A(VDE) 300V(UL) 250V(VDE)

Subject to technical modification without notice.

Typographical and other errors do not justify claim for damages.

SPECIFICATION

Type	Screw
Connection Method	Wire Protector
Mounting Type	Vertical
Orientation	Vertical
Join	Solid body non stackable
Pitch (mm)	5
Number of Poles	4
Max Current (A)	16A(UL) 24A(VDE)
Max Voltage (V)	300V(UL) 250V(VDE)
Height (mm)	11.5
Standard Colour	Green
Width (mm)	7.5
Length (mm)	20
PCB Hole Diameter (mm)	1.4
Body Material	PA66 V0