

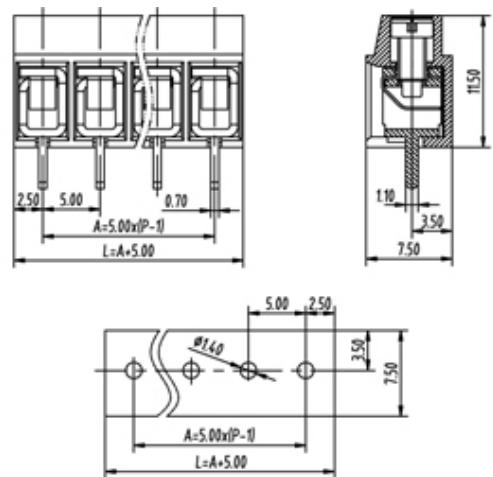

# Through Hole Mount/Wire Protected

Range: PCB Terminal Blocks, Connectors and Fuse Holders

Part Number: TL226V-02PGS

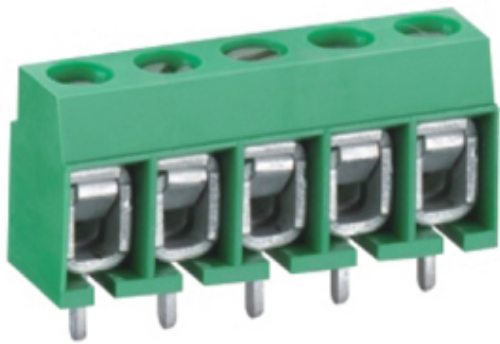

## DESCRIPTION

2 Pole Screw Wire Protector Vertical 5mm pitch 16A(UL) 24A(VDE) 300V(UL) 250V(VDE)

*Subject to technical modification without notice.*

*Typographical and other errors do not justify claim for damages.*

## SPECIFICATION

<b>Type</b>	Screw
<b>Connection Method</b>	Wire Protector
<b>Mounting Type</b>	Vertical
<b>Orientation</b>	Vertical
<b>Join</b>	Solid body non stackable
<b>Pitch (mm)</b>	5
<b>Number of Poles</b>	2
<b>Max Current (A)</b>	16A(UL) 24A(VDE)
<b>Max Voltage (V)</b>	300V(UL) 250V(VDE)
<b>Height (mm)</b>	11.5
<b>Standard Colour</b>	Green
<b>Width (mm)</b>	7.5
<b>Length (mm)</b>	10
<b>PCB Hole Diameter (mm)</b>	1.4
<b>Body Material</b>	PA66 V0