

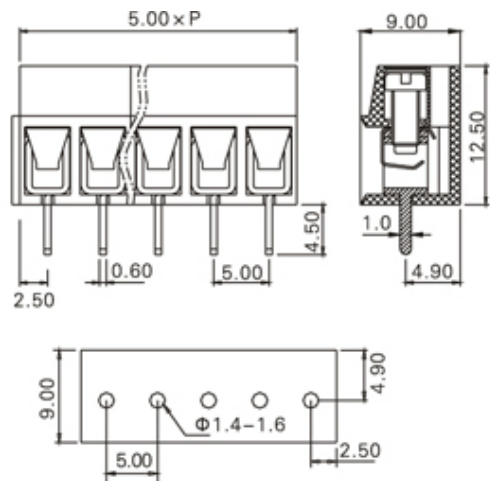

# Through Hole Mount/Wire Protected

Range: PCB Terminal Blocks, Connectors and Fuse Holders

Part Number: TL202V-04PKC



## DESCRIPTION

4 Pole Screw Wire Protector Wave - through hole Vertical 5mm pitch 16A 300V

*Subject to technical modification without notice.*

*Typographical and other errors do not justify claim for damages.*

## SPECIFICATION

<b>Type</b>	Screw
<b>Connection Method</b>	Wire Protector
<b>Mounting Type</b>	Wave - through hole
<b>Orientation</b>	Vertical
<b>Join</b>	Interlocking
<b>Pitch (mm)</b>	5
<b>Number of Poles</b>	4
<b>Min Wire Size (Sq mm)</b>	0.33
<b>Max Wire Size (Sq mm)</b>	4
<b>Max Current (A)</b>	16
<b>Max Voltage (V)</b>	300
<b>Height (mm)</b>	12.5
<b>Standard Colour</b>	Black
<b>Width (mm)</b>	9
<b>Length (mm)</b>	20
<b>Solder Pin Length (mm)</b>	4.5
<b>PCB Hole Diameter (mm)</b>	1.4-1.6
<b>Body Material</b>	PA66 V0
<b>Comments</b>	Pole sizes / no of ways not shown, please contact us for availability
<b>Min Temperature Rating °C</b>	-40
<b>Max Temperature Rating °C</b>	105
<b>Min Wire Size AWG</b>	22
<b>Max Wire Size AWG</b>	12
<b>Terminal Type</b>	Wire protected

## INDUSTRY ACCREDITATIONS

