

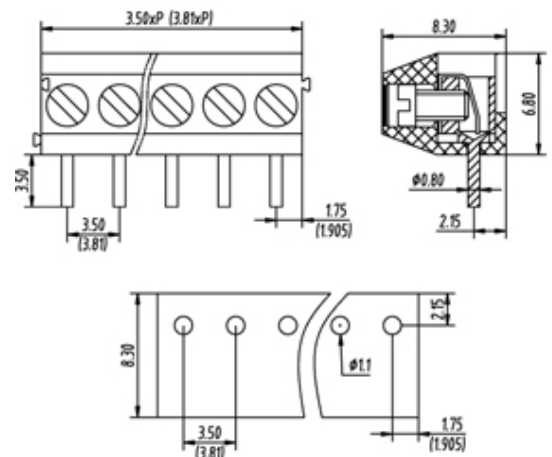

Through Hole Mount/Wire Protected

Range: PCB Terminal Blocks, Connectors and Fuse Holders

Order Code: TL100R-06PKC



DESCRIPTION

6 Pole Screw Wire Protector Wave - through hole Horizontal 3.81mm pitch 6A(UL) 300V(UL)

Subject to technical modification without notice.

Typographical and other errors do not justify claim for damages.

SPECIFICATION

| | |
|----------------------------------|---|
| Type | Screw |
| Connection Method | Wire Protector |
| Mounting Type | Wave - through hole |
| Orientation | Horizontal |
| Join | Interlocking |
| Pitch (mm) | 3.81 |
| Number of Poles | 6 |
| Min Wire Size (Sq mm) | 0.25 |
| Max Wire Size (Sq mm) | 1.5 |
| Max Current (A) | 6A(UL) |
| Max Voltage (V) | 300V(UL) |
| Height (mm) | 8.3 |
| Standard Colour | Black |
| Width (mm) | 6.8 |
| Length (mm) | 22.86 |
| Solder Pin Length (mm) | 3.5 |
| PCB Hole Diameter (mm) | 1.1 |
| Approvals Pending | UL Pending |
| Body Material | PA66 V0 |
| Comments | Pole sizes / no of ways not shown, please contact us for availability |
| Min Temperature Rating °C | -40 |
| Max Temperature Rating °C | 105 |
| Min Wire Size AWG | 24 |
| Max Wire Size AWG | 16 |
| Terminal Type | Wire protected |