

# Reducers

## Range: Cable Glands/Grommets

Order Code: R102-14025-03-EX

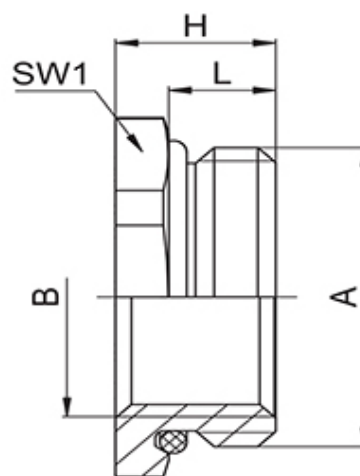

### DESCRIPTION

Reduction M40/M25 X1,5/EX thread length 8

*Subject to technical modification without notice.*

*Typographical and other errors do not justify claim for damages.*

## SPECIFICATION

<b>Product Type</b>	EX
<b>Body Material</b>	Nickel Plated Brass
<b>Min Temperature Rating °C</b>	-40
<b>Max Temperature Rating °C</b>	85
<b>IP Rating</b>	68
<b>Thread Size</b>	M40 - M25
<b>External Connecting Thread Type</b>	M25x1.5
<b>Internal Connecting Thread Type</b>	Metric, as per EN 60423
<b>Thread Length (mm)</b>	8
<b>Comments</b>	DMT 99 ATEX E0162G, Zone: II 2 G (1, 2), II 2 D (21, 22) Equipment Group IIEx e, increased safety EN 60079-0:2012, IEC 60079-0:2011, EN 60079-7:2015, IEC 60079-7:2015, EN 60079-31:2014, IEC 60079-31:2013
<b>Width Across Flat 1 (mm)</b>	43
<b>Height (mm)</b>	12
<b>Connecting Thread Size</b>	M40x1.5
<b>Additional Material Detail Category/Zone</b>	Body - Brass CuZn39Pb3 nickel plated, O-Ring - Nitrile rubber 2 G (1, 2), II 2 D (21, 22)
<b>Equipment Group</b>	Equipment Group II
<b>Standards</b>	EN 60079-0:2012, IEC 60079-0:2011, EN 60079-7:2015, IEC 60079-7:2015, EN 60079-31:2014, IEC 60079-31:2013
<b>Type of Protection</b>	Ex e, increased safety

## INDUSTRY ACCREDITATIONS

