

Reducers

Range: Cable Glands/Grommets

Order Code: R102-12012-03-EX

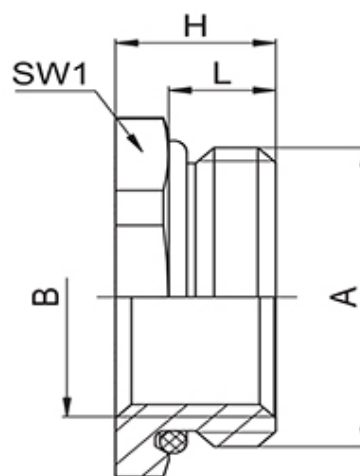

DESCRIPTION

Reduction M20/M12 X1,5/EXthread length 6

Subject to technical modification without notice.

Typographical and other errors do not justify claim for damages.

SPECIFICATION

Product Type	EX
Body Material	Nickel Plated Brass
Min Temperature Rating °C	-40
Max Temperature Rating °C	85
IP Rating	68
Thread Size	M20 - M12
External Connecting Thread Type	M12x1.5
Internal Connecting Thread Type	Metric, as per EN 60423
Thread Length (mm)	6
Comments	DMT 99 ATEX E0162G, Zone: II 2 G (1, 2), II 2 D (21, 22) Equipment Group IIEx e, increased safety EN 60079-0:2012, IEC 60079-0:2011, EN 60079-7:2015, IEC 60079-7:2015, EN 60079-31:2014, IEC 60079-31:2013
Width Across Flat 1 (mm)	22
Height (mm)	9
Connecting Thread Size	M20x1.5
Additional Material Detail Category/Zone	Body - Brass CuZn39Pb3 nickel plated, O-Ring - Nitrile rubber 2 G (1, 2), II 2 D (21, 22)
Equipment Group	Equipment Group II
Standards	EN 60079-0:2012, IEC 60079-0:2011, EN 60079-7:2015, IEC 60079-7:2015, EN 60079-31:2014, IEC 60079-31:2013
Type of Protection	Ex e, increased safety

INDUSTRY ACCREDITATIONS

