

Enlargers

Range: Cable Glands/Grommets

Part Number: E102-12532-03-EX

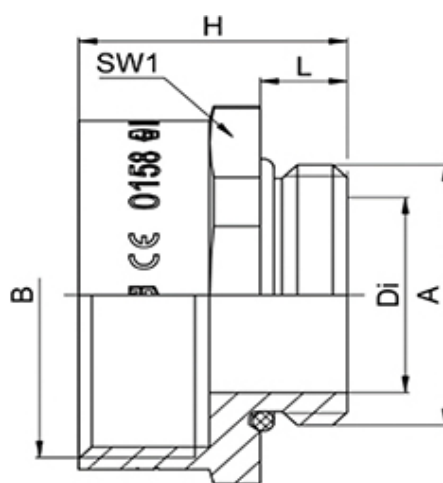

DESCRIPTION

Enlarger M25M32/EX thread length 7

*Subject to technical modification without notice.
Typographical and other errors do not justify claim for damages.*

SPECIFICATION

Product Type	EX
Body Material	Nickel Plated Brass
Min Temperature Rating °C	-40
Max Temperature Rating °C	85
IP Rating	68
Hole Diameter (mm)	21
Thread Size	M25-M32
External Connecting Thread Type	M32x1.5
Internal Connecting Thread Type	Metric, as per EN 60423
Thread Length (mm)	7
Comments	DMT 99 ATEX E0162G, Zone: II 2 G (1, 2), II 2 D (21, 22) Equipment Group IIEx e, increased safety EN 60079-0:2012, IEC 60079-0:2011, EN 60079-7:2015, IEC 60079-7:2015, EN 60079-31:2014, IEC 60079-31:2013
Width Across Flat 1 (mm)	34
Height (mm)	20.5
Connecting Thread Size	M25x1.5
Additional Material Detail Category/Zone	Body - Brass CuZn39Pb3 nickel plated, O-Ring - Nitrile rubber 2 G (1, 2), II 2 D (21, 22)
Equipment Group	Equipment Group II
Standards	EN 60079-0:2012, IEC 60079-0:2011, EN 60079-7:2015, IEC 60079-7:2015, EN 60079-31:2014, IEC 60079-31:2013
Type of Protection	Ex e, increased safety

INDUSTRY ACCREDITATIONS

