

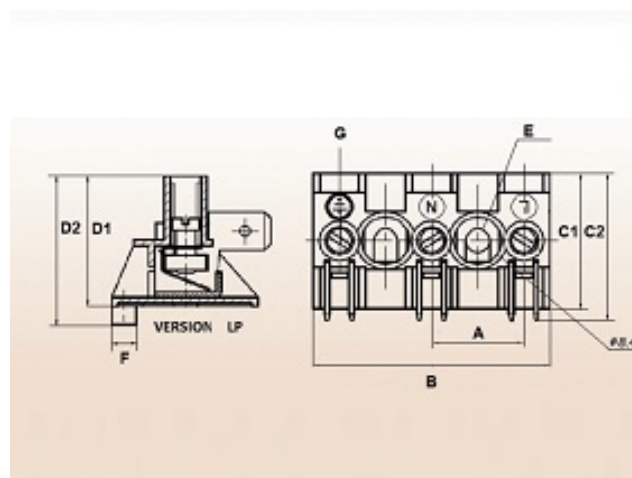

Screw to Tab Terminal Blocks

Range: Emech Terminals/Accessories

Part Number: HY270/3 FV



DESCRIPTION

3 Pole screw to tab terminal block, without wire protector

Subject to technical modification without notice.

Typographical and other errors do not justify claim for damages.

SPECIFICATION

Number of Poles	3
Tabs Per Pole	3
Tab Size (mm)	6.3x0.8
Terminal Material	Zinc-plated steel
Body Material	Polyamide, glass fibre reinforced
UL94 Rating	UL94V0
Max Conductor Size (Sq mm)	4
Min Conductor Size AWG	20
Max Conductor Size AWG	12
Max Current (A)	25
Max Voltage (V)	450
Max Temperature Rating °C	150
Pitch (mm)	16
Height (mm)	24.6
Width (mm)	26
Length (mm)	41

INDUSTRY ACCREDITATIONS

