

Fuse Holders

Range: PCB Terminal Blocks, Connectors and Fuse Holders

Order Code: DFH12

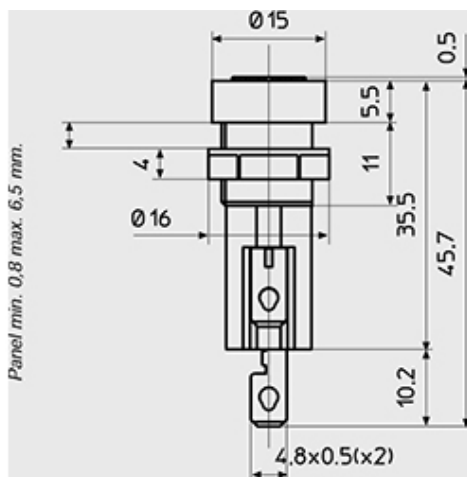

DESCRIPTION

5x20mm Low Profile Panel Mounting Fuseholder

Subject to technical modification without notice.

Typographical and other errors do not justify claim for damages.

SPECIFICATION

Max Current (A)	6.3
Max Voltage (V)	250
Dielectric Strength	>3000 Vac / 60
Power Dissipation (w)	2.5
Insulation Resistance (mOhm)	>10 ¹² M