

# Tab to Tab Terminal Blocks

## Range: Emech Terminals/Accessories

Order Code: HY401/3

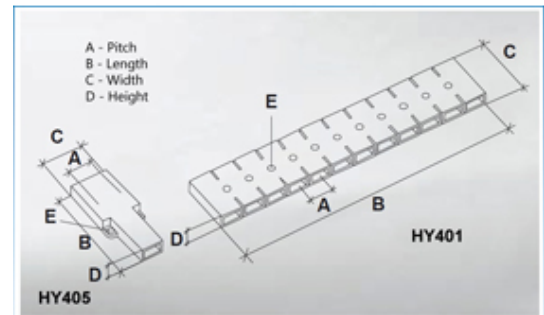

### DESCRIPTION

3 pole transparent Nylon tab to tab terminal block 12.5mm pitch

*Subject to technical modification without notice.*

*Typographical and other errors do not justify claim for damages.*

## SPECIFICATION

<b>Number of Poles</b>	3
<b>Tab Size (mm)</b>	6.35x0.8
<b>Terminal Material</b>	Copper and nickel plated steel
<b>Body Material</b>	Nylon
<b>Colour</b>	Transparent
<b>UL94 Rating</b>	UL94V0
<b>Max Conductor Size (Sq mm)</b>	2.5
<b>Max Current (A)</b>	24
<b>Max Voltage (V)</b>	450
<b>Pitch (mm)</b>	12.5
<b>Height (mm)</b>	7.5
<b>Width (mm)</b>	29
<b>Length (mm)</b>	36.5

## INDUSTRY ACCREDITATIONS

