

Fused Pillar Terminal Blocks

Range: Emech Terminals/Accessories

Part Number: HY133/3 LPMT

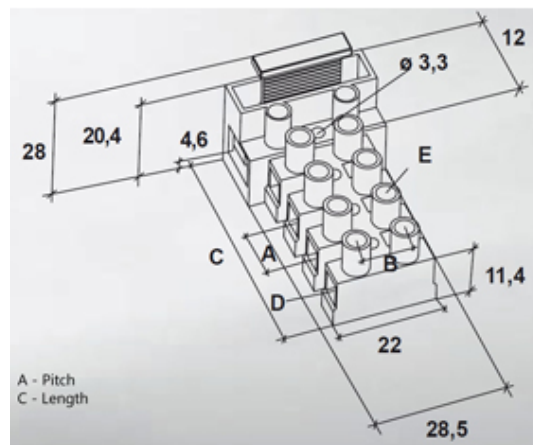

DESCRIPTION

3 pole grey polyamide PA6.8 wire protected fused pillar terminal block 10mm pitch 24a 450v

Subject to technical modification without notice.

Typographical and other errors do not justify claim for damages.

SPECIFICATION

Number of Poles	3
Terminal Material	OT58 nickel plated
Terminal Type	Wire Protected
Body Material	Polyamide PA6.8
Colour	Grey
Max Conductor Size (Sq mm)	2.5
Max Current (A)	24
Max Voltage (V)	450
Pitch (mm)	10
Height (mm)	28
Width (mm)	28.5
Length (mm)	31
Comments	Interlockable of on 1 side. With screw and washer (4) for earth contact
Terminal Screw Material	White zinc plated steel
Wire Protection Material	Stainless steel

INDUSTRY ACCREDITATIONS

