

## 50.620 M/EMV/EX

Perfect cable gland EMV-EX M20X1,5thread length 6, min/max cable dia 9-13

EMV / EMC

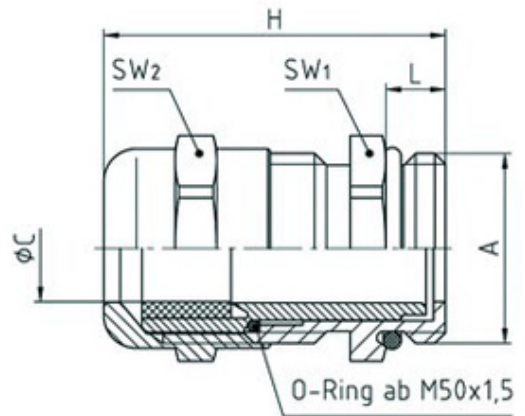

### SPECIFICATION

Product Type	EX
Sealing Ring Material	Polychloroprene-Nitrile rubber CR/NBR
Body Material	Nickel Plated Brass
Min Temperature °C	-20
Max Temperature °C	80
IP Rating	68
Thread Size	M20
Clamping Range Min (mm)	9
Clamping Range Max (mm)	13
Lamellar Insert Material	Polyamide PA6 V-2
External Connecting Thread Type	Metric
Thread Length (mm)	6
Comments	DMT 99 ATEX E0162G, 2D and 3G/1, 2, 21, 22 Equipment Group IIEx e, increased safety EN 60079-0/EN 60078-7
Width Across Flat 1 (mm)	22
Width Across Flat 2 (mm)	22
Height (mm)	33
Connecting Thread Size	M20x1.5
Additional Material Detail	Body - Brass CuZn39Pb3 nickel plated, Dust cap - Polyethylene PE-LD, O-Ring - Nitrile rubber
Category/Zone	2G, 2D and 3G/1, 2, 21, 22
Equipment Group	Equipment Group II
Standards	EN60079-1/EN60079-7/EN61241-0/EN61241-1
Type of Protection	Ex e, increased safety

### DISTRIBUTORS

