

# Pluggable Pin Header (Male) - Single Row PCB Header

Range: PCB Terminal Blocks, Connectors and Fuse Holders

Part Number: TLPH-500V-6P

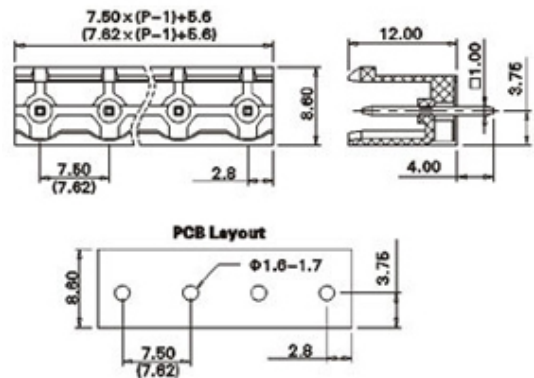
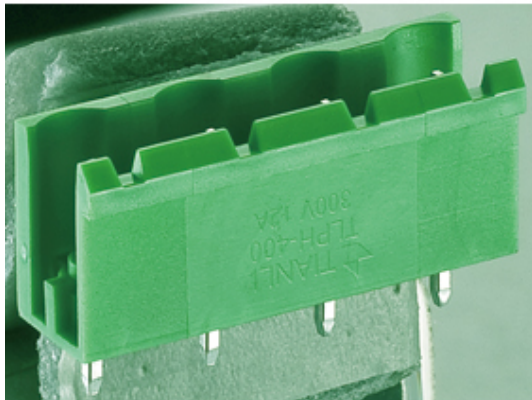

## DESCRIPTION

6 Pole Vertical PCB terminal block 7.62mm pitch 12A 300V

*Subject to technical modification without notice.*

*Typographical and other errors do not justify claim for damages.*

## SPECIFICATION

Type	PCB mount - Male header
Mounting Type	Wave - through hole
Orientation	Vertical
Join	Solid body non stackable
Pitch (mm)	7.62
Open/Closed/Screw/Flange	Open End
Number of Poles	6
Max Current (A)	12
Max Voltage (V)	300
Height (mm)	8.6
Standard Colour	Green
Width (mm)	12
Length (mm)	43.5
Solder Pin Length (mm)	4
PCB Hole Diameter (mm)	1.6-1.7
Comments	Pole sizes / no of ways not shown, please contact us for availability
Max Temperature Rating °C	105
Max Wire Size AWG	-40

## INDUSTRY ACCREDITATIONS

