

50.725 M/L/EX

Perfect cable gland EX M25X1,5 thread length 11, min/max cable dia 11-16 Flexible cable installation

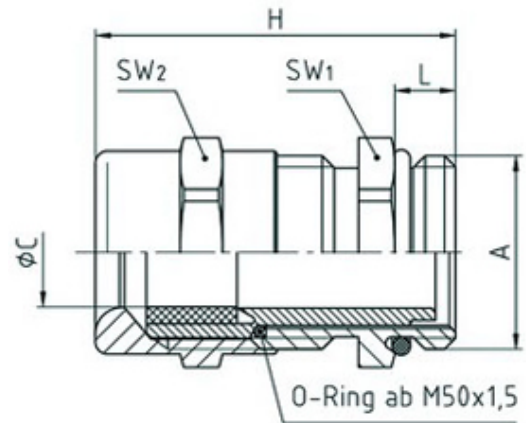

SPECIFICATION

Product Type	EX
Sealing Ring Material	Polychloroprene-Nitrile rubber CR/NBR
Body Material	Nickel Plated Brass
Min Temperature °C	-20
Max Temperature °C	80
IP Rating	68
Thread Size	M25
Clamping Range Min (mm)	11
Clamping Range Max (mm)	16
Lamellar Insert Material	Polyamide PA6 V-2
External Connecting Thread Type	Metric
Thread Length (mm)	11
Comments	DMT 99 ATEX E0162G, 2D and 3G/1, 2, 21, 22 Equipment Group IIEx e, increased safety EN 60079-0/EN 60078-7
Width Across Flat 1 (mm)	27
Width Across Flat 2 (mm)	27
Height (mm)	44
Connecting Thread Size	M25x1.5
Additional Material Detail	Body - Brass CuZn39Pb3 nickel plated, Dust cap - Polyethylene PE-LD, O-Ring - Nitrile rubber
Category/Zone	2G, 2D and 3G/1, 2, 21, 22
Equipment Group	Equipment Group II
Standards	EN60079-1/EN60079-7/EN61241-0/EN61241-1
Type of Protection	Ex e, increased safety