

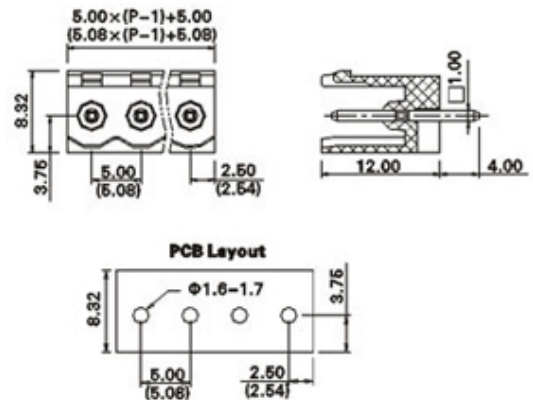

Pluggable Pin Header (Male) - Single Row PCB Header

Range: PCB Terminal Blocks, Connectors and Fuse Holders

Part Number: TLPH-300V-05P



DESCRIPTION

5 Pole PCB mount - Male header Wave - through hole Vertical 5.08mm pitch 16A(UL)/15A(VDE) 300V(UL) 250V(VDE)

Subject to technical modification without notice.

Typographical and other errors do not justify claim for damages.

SPECIFICATION

| | |
|----------------------------------|---|
| Type | PCB mount - Male header |
| Mounting Type | Wave - through hole |
| Orientation | Vertical |
| Join | Solid body non stackable |
| Pitch (mm) | 5.08 |
| Open/Closed/Screw/Flange | Open End |
| Number of Poles | 5 |
| Max Current (A) | 16A(UL)/15A(VDE) |
| Max Voltage (V) | 300V(UL) 250V(VDE) |
| Height (mm) | 12 |
| Standard Colour | Green |
| Width (mm) | 8.45 |
| Length (mm) | 25.4 |
| Solder Pin Length (mm) | 4 |
| PCB Hole Diameter (mm) | 1.6-1.7 |
| Body Material | PA66 V0 |
| Comments | Pole sizes / no of ways not shown, please contact us for availability |
| Min Temperature Rating °C | -40 |
| Max Temperature Rating °C | 105 |

INDUSTRY ACCREDITATIONS

