

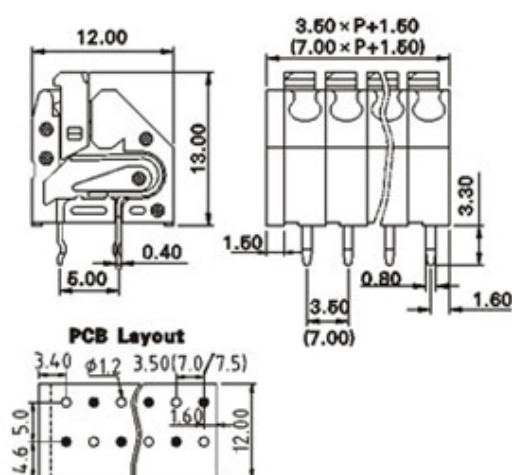

# Screwless - Push Wire

Range: PCB Terminal Blocks, Connectors and Fuse Holders

Part Number: TLM002D-02P



## DESCRIPTION

2 Pole Spring - Screwless Pushbutton Wave - through hole Short pin close to side cover 3.5mm pitch 2A 250V

*Subject to technical modification without notice.*

*Typographical and other errors do not justify claim for damages.*

## SPECIFICATION

Type	Spring - Screwless
Connection Method	Pushbutton
Mounting Type	Wave - through hole
Orientation	Short pin close to side cover
Join	End stackable
Pitch (mm)	3.5
Number of Poles	2
Min Wire Size (Sq mm)	0.33
Max Wire Size (Sq mm)	1.75
Max Current (A)	2
Max Voltage (V)	250
Height (mm)	13
Standard Colour	Grey
Width (mm)	12
Length (mm)	8.5
Solder Pin Length (mm)	3.3
PCB Hole Diameter (mm)	1.2
Body Material	PA66 V0
Comments	Pole sizes / no of ways not shown, please contact us for availability
Min Temperature Rating °C	-40
Max Temperature Rating °C	105
Min Wire Size AWG	22
Max Wire Size AWG	14

## INDUSTRY ACCREDITATIONS

