

## 50.716 M/EX

Perfect cable gland EX M16X1,5thread length 5, min/max cable dia 5-9 Flexible cable installation

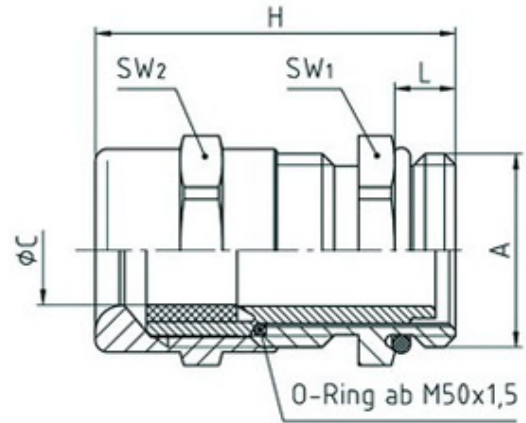

### SPECIFICATION

<b>Product Type</b>	EX
<b>Sealing Ring Material</b>	Polychloroprene-Nitrile rubber CR/NBR
<b>Body Material</b>	Nickel Plated Brass
<b>Min Temperature °C</b>	-20
<b>Max Temperature °C</b>	80
<b>IP Rating</b>	68
<b>Thread Size</b>	M16
<b>Clamping Range Min (mm)</b>	5
<b>Clamping Range Max (mm)</b>	9
<b>Lamellar Insert Material</b>	Polyamide PA6 V-2
<b>External Connecting Thread Type</b>	Metric
<b>Thread Length (mm)</b>	5
<b>Comments</b>	DMT 99 ATEX E0162G, 2D and 3G/1, 2, 21, 22 Equipment Group IIEx e, increased safety EN 60079-0/EN 60078-7
<b>Width Across Flat 1 (mm)</b>	17
<b>Width Across Flat 2 (mm)</b>	17
<b>Height (mm)</b>	30
<b>Connecting Thread Size</b>	M16x1.5
<b>Additional Material Detail</b>	Body - Brass CuZn39Pb3 nickel plated, Dust cap - Polyethylene PE-LD, O-Ring - Nitrile rubber
<b>Category/Zone</b>	2G, 2D and 3G/1, 2, 21, 22
<b>Equipment Group</b>	Equipment Group II
<b>Standards</b>	EN60079-1/EN60079-7/EN61241-0/EN61241-1
<b>Type of Protection</b>	Ex e, increased safety