

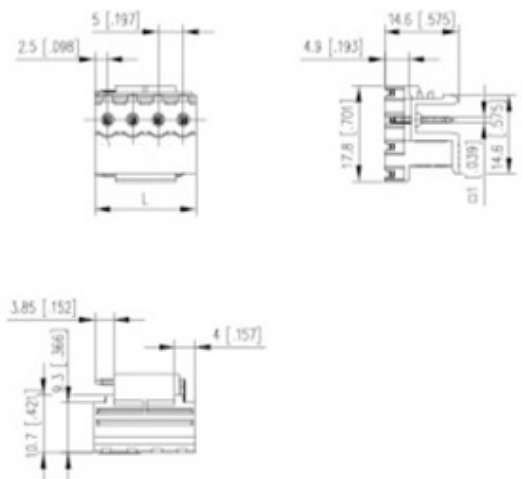

# Plug and Socket PCB Terminal Blocks

Range: PCB Terminal Blocks, Connectors and Fuse Holders

Order Code: 31337104



## DESCRIPTION

4 Pole horizontal pin headers 5mm pitch 12A 250V

*Subject to technical modification without notice.*

*Typographical and other errors do not justify claim for damages.*

## SPECIFICATION

Type	PCB mount - Male header
Mounting Type	Wave / Through Hole Reflow compatible
Orientation	Horizontal
Pitch (mm)	5
Open/Closed/Screw/Flange	Open End
Number of Poles	4
Max Current (A)	12
Max Voltage (V)	250
Height (mm)	14.6
Standard Colour	Black
Width (mm)	14.6
Length (mm)	20
Solder Pin Length (mm)	3.85
PCB Hole Diameter (mm)	1.4
Comments	Pole sizes / no of ways not shown, please contact us for availability
Pin Style	Solderable
Tracking Resistance CTI (v)	600

## INDUSTRY ACCREDITATIONS

