

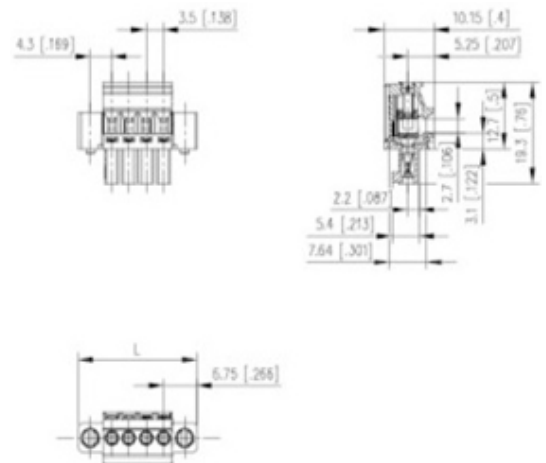

Plug and Socket PCB Terminal Blocks

Range: PCB Terminal Blocks, Connectors and Fuse Holders

Order Code: 31634103



DESCRIPTION

3 Pole horizontal screw female plug terminal block 3.5mm pitch 10A 130V

Subject to technical modification without notice.

Typographical and other errors do not justify claim for damages.

SPECIFICATION

| | |
|------------------------------------|---|
| Type | Cable mount - Female plug |
| Connection Method | Screw |
| Mounting Type | Rising clamp |
| Orientation | Horizontal |
| Join | Solid body non stackable |
| Pitch (mm) | 3.5 |
| Open/Closed/Screw/Flange | Screw flange |
| Number of Poles | 3 |
| Min Wire Size (Sq mm) | 0.08 |
| Max Wire Size (Sq mm) | 1.5 |
| Max Current (A) | 10 |
| Max Voltage (V) | 130 |
| Height (mm) | 19.3 |
| Standard Colour | Black |
| Width (mm) | 10.15 |
| Length (mm) | 20.5 |
| Comments | Pole sizes / no of ways not shown, please contact us for availability |
| IP Rating | 20 |
| Min Temperature Rating °C | 16 |
| Min Wire Size AWG | 28 |
| Pin Style | Pluggable |
| Tracking Resistance CTI (v) | 600 |

INDUSTRY ACCREDITATIONS

