

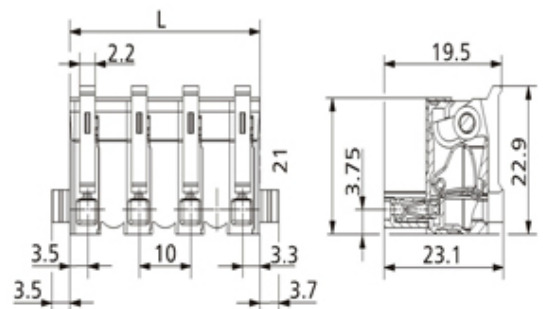

Plug and Socket PCB Terminal Blocks

Range: PCB Terminal Blocks, Connectors and Fuse Holders

Order Code: ASP1290422

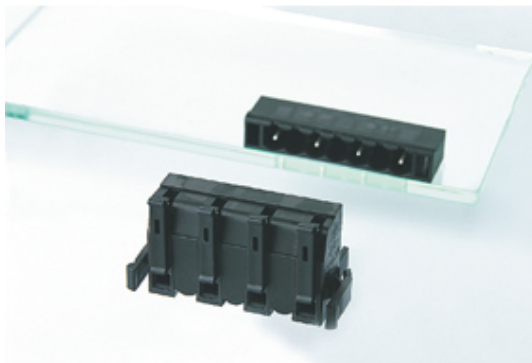

DESCRIPTION

4 Pole vertical spring PCB terminal block 10mm pitch 10A 750V

Subject to technical modification without notice.

Typographical and other errors do not justify claim for damages.

SPECIFICATION

Type	Cable mount - Female plug
Connection Method	Spring - Screwless
Mounting Type	Spring clamp
Orientation	Vertical
Join	End stackable
Pitch (mm)	10
Number of Poles	4
Min Wire Size (Sq mm)	0.08
Max Wire Size (Sq mm)	2.5
Max Current (A)	10
Max Voltage (V)	>750
Height (mm)	22.9
Standard Colour	Black
Width (mm)	15
Length (mm)	36.8
Comments	Pole sizes / no of ways not shown, please contact us for availability
IP Rating	20
Min Temperature Rating °C	12
Min Wire Size AWG	28
Pin Style	Pluggable
Tracking Resistance CTI (v)	400