

PCB Plugs and Sockets

Range: Clearance

Part Number: ASP0461122

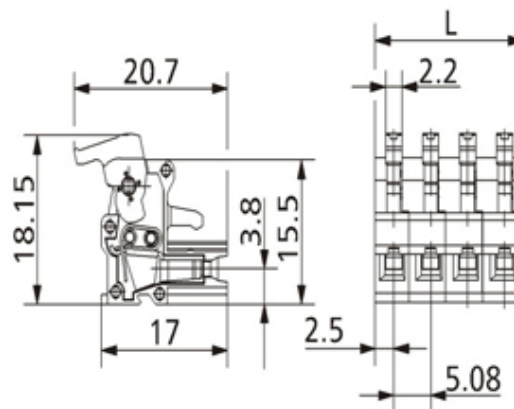
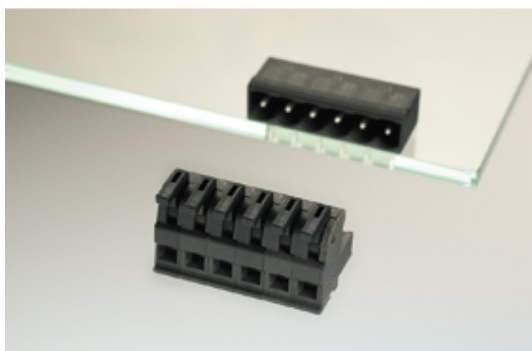

DESCRIPTION

CLEARANCE - 11 Pole vertical spring PCB terminal block 5.08mm pitch 10A 450V

Subject to technical modification without notice.

Typographical and other errors do not justify claim for damages.

SPECIFICATION

Height (mm)	18.15
Width (mm)	20.7
Length (mm)	55.8
Max Current (A)	10
Max Voltage (V)	450
Comments	Pole sizes / no of ways not shown, please contact us for availability
IP Rating	20
Number of Poles	11
Pitch (mm)	5.08
Tracking Resistance CTI (v)	400