

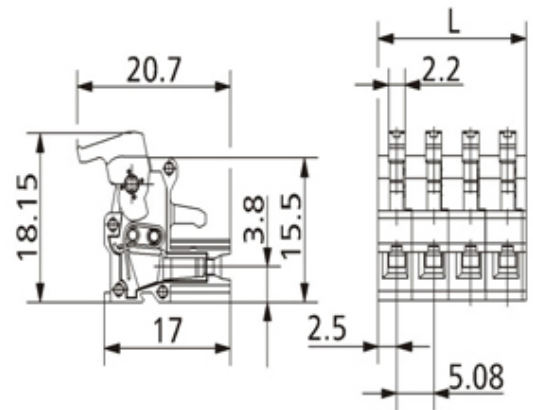

# Plug and Socket PCB Terminal Blocks

Range: PCB Terminal Blocks, Connectors and Fuse Holders

Order Code: ASP0460522

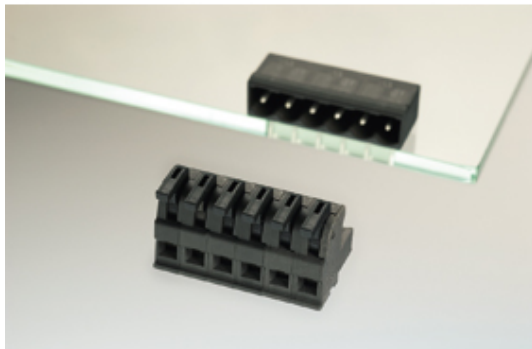

## DESCRIPTION

5 Pole vertical spring PCB terminal block 5.08mm pitch 10A 450V

*Subject to technical modification without notice.*

*Typographical and other errors do not justify claim for damages.*

## SPECIFICATION

<b>Type</b>	Cable mount - Female plug
<b>Connection Method</b>	Spring - Screwless
<b>Mounting Type</b>	Spring clamp
<b>Orientation</b>	Vertical
<b>Join</b>	End stackable
<b>Pitch (mm)</b>	5.08
<b>Number of Poles</b>	5
<b>Min Wire Size (Sq mm)</b>	0.08
<b>Max Wire Size (Sq mm)</b>	1.5
<b>Max Current (A)</b>	10
<b>Max Voltage (V)</b>	450
<b>Height (mm)</b>	18.15
<b>Standard Colour</b>	Black
<b>Width (mm)</b>	20.7
<b>Length (mm)</b>	25.32
<b>Comments</b>	Pole sizes / no of ways not shown, please contact us for availability
<b>IP Rating</b>	20
<b>Min Temperature Rating °C</b>	16
<b>Min Wire Size AWG</b>	28
<b>Pin Style</b>	Pluggable
<b>Tracking Resistance CTI (v)</b>	400